



PicoScope 2200A Series

PC Oscilloscopes

User's Guide



Contents

1 Introduction	1
1 Safety Information	2
1 Safety symbols	3
2 Maximum input ranges	4
3 Grounding	5
4 Environment	5
5 Care of the product	6
2 Conformance	6
1 FCC notice	6
2 CE notice	6
3 Software licence conditions	7
4 Returns and upgrades	7
5 Trademarks	7
6 Warranty	8
2 Product information	9
1 Model selector	9
2 PicoScope 2200A Series pack contents and accessories	9
3 System requirements	10
4 Installation instructions	10
5 Connections	11
1 Connector diagrams	11
2 Signal inputs	11
3 Compensating probes	11
4 AWG connector	12
5 USB port	12
3 Glossary	13
4 Appendix A: Declaration of Conformity	15
Index	17



1 Introduction

Thank you for buying a PicoScope 2200A Series Oscilloscope from Pico Technology.

The PicoScope 2200A Series oscilloscopes are compact units designed to replace traditional benchtop oscilloscopes costing many times the price.



Here are some of the benefits provided by the PicoScope 2200A series:

- **Portability:** Take the unit with you and plug it in to any Windows PC.
- **Performance:** Fast sampling from 100 Msamples per second to 1 Gsample per second, probe-tip bandwidths from 10 MHz to 200 MHz and fast USB 2.0 interface. See [Model Selector](#) for details of each scope model.
- **Flexibility:** Use it as an oscilloscope, spectrum analyzer, or high-speed data acquisition interface.
- **Programmability:** APIs are available for all oscilloscopes in our 2200A range. The Application Programming Interfaces (APIs) let you write your own programs, in your chosen programming language, to control all the features of the scope.
- **Long-term support:** Software upgrades are available to download from our [website](#). You can also call our specialists for technical support. You can continue to use both of these services free of charge for the lifetime of the product.
- **Value for money:** Buying a PicoScope PC Oscilloscope means that you don't have to pay twice for all the features that you already have in your PC. The PicoScope 2200A Series oscilloscope contains the special hardware you need and nothing more.
- **Convenience:** The software makes full use of the display, storage, user interface and networking built in to your PC.
- **Dependability:** Your scope is backed by a 5-year warranty against manufacturing faults.

Additional information

For full technical specifications, see the following data sheet:

- [PicoScope 2200A Series Data Sheet \(MM012\)](#)

The following manuals explain how to use the API to control a PicoScope 2200A Series Oscilloscope:

- [PicoScope 2000 Series Programmer's Guide: *PicoScope 2204A/5A*](#)
- [PicoScope 2000 Series \(A API\) Programmer's Guide: *PicoScope 2206A/7A/8A*](#)

These documents are available from <http://www.picotech.com>.

1.1 Safety Information

To prevent possible electrical shock, fire, personal injury, or damage to the product, carefully read this safety information before attempting to install or use the product. In addition, follow all generally accepted safety practices and procedures for working with and near electricity.

The product has been designed and tested in accordance with the European standard publication EN 61010-1: 2010, and left the factory in a safe condition.

The following safety descriptions are found throughout this guide:









A **WARNING** identifies conditions or practices that could result in injury or death.

A **CAUTION** identifies conditions or practices that could result in damage to the product or equipment to which it is connected.

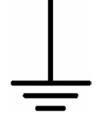
Each of these safety instructions applies to all of the 2200A Series oscilloscopes covered by this User's Guide, unless otherwise specified.

1.1.1 Safety symbols

These safety and electrical symbols may appear on the product or in this guide.

Symbol	Description
	Direct current.
	Alternating current.
	Earth (ground) terminal. The terminal can be used to make a measurement ground connection. The terminal is not a safety or protective earth.
	Chassis ground terminal. This symbol is now used in place of the equipotential symbol.
	Equipment protected throughout by double insulation or reinforced insulation.
	Possibility of electric shock.
	Caution. Appearance on the product indicates a need to read this safety and operation instruction.
	Static awareness. Static discharge can damage parts.
CAT	IEC 61010 overvoltage category.
	Do not dispose of this product as unsorted municipal waste.

**WARNING**

To prevent injury or death, use the product only as instructed. Protection provided by the product may be impaired if used in a manner not specified by the manufacturer.

1.1.2 Maximum input ranges

Observe all terminal ratings and warnings marked on the product.

The table below indicates the full scale measurement range and overvoltage protection range for each oscilloscope model. The full scale measurement ranges are the maximum voltages that can be accurately measured by each instrument. The overvoltage protection ranges are the maximum voltages that can be applied without damaging the oscilloscope.



WARNING

To prevent electric shock, do not attempt to measure voltages outside the specified full scale measurement range below.

Full scale measurement range	Overvoltage protection	
	Input channels / EXT trigger	Signal generator
±20 V	±100 V	±10 V



WARNING

Signals exceeding the voltage limits in the table below are defined as "hazardous live" by EN 61010. To prevent electric shock, take all necessary safety precautions when working on equipment where hazardous live voltages may be present.

Signal voltage limits of EN 61010		
±70 V DC	33 V AC RMS	±46.7 V pk max.

WARNING

The PicoScope 2000 Series oscilloscopes are not designed to measure hazardous live signals as defined by EN 61010. To prevent electric shock, do not attempt to measure voltages outside of the limits shown in the table above or the specified full scale measurement range, whichever is lower.

WARNING

To prevent injury or death, the oscilloscope must not be directly connected to the mains (line power). To measure mains voltages, use a differential isolating probe specifically rated for mains use, such as the TA041 listed at www.picotech.com.



CAUTION

Exceeding the overload protection range on any connector can cause permanent damage to the oscilloscope and other connected equipment.

1.1.3 Grounding

**WARNING**

The oscilloscope's ground connection through the USB cable is for measurement purposes only. The oscilloscope does not have a protective safety ground.

WARNING

Never connect the ground input (chassis) to any electrical power source. To prevent personal injury or death, use a voltmeter to check that there is no significant AC or DC voltage between the oscilloscope ground and the point to which you intend to connect it.

**CAUTION**

Applying a voltage to the ground input is likely to cause permanent damage to the oscilloscope, the attached computer, and other equipment.

CAUTION

To prevent measurement errors caused by poor grounding, always use the high-quality USB cable supplied with the oscilloscope.

1.1.4 Environment

**WARNING**

To prevent injury or death, do not use in wet or damp conditions, or near explosive gas or vapor.

**CAUTION**

To prevent damage, always use and store your oscilloscope in appropriate environments.

	Storage	Operating
Temperature	-20 °C to +60 °C	0 °C to +40 °C +20 to +30 °C (for quoted accuracy)
Humidity	5% to 95% RH (non-condensing)	5% to 85% RH (non-condensing)

1.1.5 Care of the product

The oscilloscope and its accessories contain no user-serviceable parts. Repair and servicing require specialized test equipment and must only be performed by Pico Technology or an approved service provider. There may be a charge for these services unless covered by the Pico five year warranty.



WARNING

To prevent injury or death, do not use the instrument if it appears to be damaged in any way, and stop use immediately if you are concerned by any abnormal operations.

WARNING

When cleaning the oscilloscope, use a soft cloth and a solution of mild soap or detergent in water. To prevent electric shock, do not allow liquids to enter the casing, as this will cause damage to the electronics or insulation inside.



CAUTION

Do not tamper with or disassemble the oscilloscope, connectors or accessories. Internal damage will affect performance.

1.2 Conformance

1.2.1 FCC notice

This equipment has been tested and found to comply with the limits for a Class A digital device, pursuant to Part 15 of the FCC Rules. These limits are designed to provide reasonable protection against harmful interference when the equipment is operated in a commercial environment. This equipment generates, uses, and can radiate radio frequency energy and, if not installed and used in accordance with the instruction manual, may cause harmful interference to radio communications. Operation of this equipment in a residential area is likely to cause harmful interference in which case the user will be required to correct the interference at his or her own expense.

For safety and maintenance information see the [safety warning](#).

1.2.2 CE notice

The product meets the intent of the EMC directive 2004/108/EC and has been tested to EN61326-1:2006 Class A Emissions and Basic Immunity.

The product also meets the intent of the Low Voltage Directive and has been designed to meet BS EN 61010-1:2010 Safety requirements for electrical equipment for measurement, control, and laboratory use.

1.3 Software licence conditions

The material contained in this [software](#) release is licensed, not sold. Pico Technology Limited ("Pico") grants a license to the person who installs this software, subject to the conditions below.

Access. The licensee agrees to allow access to this software only to persons who have been informed of and agree to abide by these conditions.

Usage. The software in this release is for use only with Pico Technology products or with data collected using Pico products.

Copyright. Pico claims the copyright of and reserves the rights to all material (software, documents etc.) contained in this release.

Liability. Pico and its agents shall not be liable for any loss, damage or injury, howsoever caused, related to the use of Pico equipment or software, unless excluded by statute.

Fitness for purpose. No two applications are the same, so Pico cannot guarantee that its equipment or software is suitable for a given application. It is therefore the user's responsibility to ensure that the product is suitable for the user's application.

Mission-critical applications. Because the software runs on a computer that may be running other software products, and may be subject to interference from these other products, this license specifically excludes usage in 'mission-critical' applications, for example life-support systems.

Viruses. This software was continuously monitored for viruses during production. However, the user is responsible for virus checking the software once it is installed.

Support. No software is ever error-free, but if you are dissatisfied with the performance of this software, please contact our technical support staff.

1.4 Returns and upgrades

Returns. If you are not completely satisfied with this product, please return it to your supplier within fourteen days of purchase for a full refund.

Software upgrades. We provide software upgrades, free of charge, from our website at www.picotech.com. We reserve the right to charge for updates or replacements sent out on physical media.

1.5 Trademarks

Windows is a trademark of Microsoft Corporation in the United States and other countries. *Pico Technology* and *PicoScope* are internationally registered trademarks of Pico Technology Ltd. *Pico Technology* and *PicoScope* are trademarks of Pico Technology Limited, registered in the United Kingdom and other countries. *PicoScope* and *Pico Technology* are registered in the U.S. Patent and Trademark Office.

1.6 Warranty

Pico Technology warrants upon delivery, and for a period of five years from the date of delivery, that the Goods will be free from defects in material and workmanship.

Pico Technology shall not be liable for a breach of the warranty if the defect has been caused by fair wear and tear, willful damage, negligence, abnormal working conditions or failure to follow Pico Technology's spoken or written advice on the storage, installation, commissioning, use or maintenance of the Goods or (if no advice has been given) good trade practice, or if the Customer alters or repairs such Goods without the written consent of Pico Technology.

2 Product information

2.1 Model selector

Model	PicoScope 2204A	PicoScope 2205A	PicoScope 2206A	PicoScope 2207A	PicoScope 2208A
Number of channels	2				
Vertical resolution	8 bits				
Analog bandwidth	10 MHz	25 MHz	50 MHz	100 MHz	200 MHz
AWG	100 kHz	100 kHz	1 MHz	1 MHz	1 MHz
Maximum sampling rate					
Real-time - one channel in use	100 MS/s	200 MS/s	500 MS/s	1 GS/s	1 GS/s
Real-time - two channels in use	50 MS/s	100 MS/s	250 MS/s	500 MS/s	500 MS/s
Equivalent-time (ETS)	2 GS/s	4 GS/s	5 GS/s	10 GS/s	10 GS/s
Buffer size (shared between enabled channels)	8 k	16 k	32 k	40 k	48 k
Dimensions (including connectors)	142 x 92 x 19 mm (5.6 x 3.6 x 0.8 in.)				

2.2 PicoScope 2200A Series pack contents and accessories

Your PicoScope 2200A Series oscilloscope package contains the following items:

Reorder code	Quantity	Description
	1	PicoScope 2200A Series oscilloscope
	2	Probes for your PicoScope 2200A Series oscilloscope (see below)
TA207	1	USB 2.0 cable, 1.2 m
DI025	1	Software and Reference CD, with PicoScope software, drivers , and example programs
	1	USB Oscilloscope Quick Start Guide

Re-order codes for PicoScope 2200A Series oscilloscope probes:

Order code	Description
PP787	2 x MI007 60 MHz probes for 2204A, 2205A and 2206A
PP821	2 x TA132 150 MHz probes for 2207A
PP822	2 x TA131 250 MHz probes for 2208A

2.3 System requirements

To ensure that your PicoScope 2200A Series oscilloscope operates correctly, you must have a computer with at least the minimum system requirements to run one of the supported operating systems, as shown in the following table. The performance of the software will increase with more powerful PCs, including those with multi-core processors.

Item	Specification
Operating system	Windows XP (SP3), Windows Vista, Windows 7, Windows 8 (not Windows RT)
	32 bit and 64 bit versions supported
Processor	As required by Windows
Memory	
Free disk space	
Ports	USB 2.0 or USB 3.0 port USB 1.1 port (absolute minimum)*

* The oscilloscope will run slowly on a USB 1.1 port. This configuration is not recommended.

2.4 Installation instructions

IMPORTANT
Do not connect your oscilloscope to the PC before you have installed the PicoScope software.
If you do, Windows might not recognise the scope device correctly.

Procedure

- Follow the instructions in the Installation Guide included with your product package.
- Connect your PC Oscilloscope to the PC using the USB cable supplied.

Checking the installation

Once you have installed the software and connected the PC Oscilloscope to the PC, start the [PicoScope](#) software. PicoScope should now display any signal connected to the scope inputs. If a probe is connected to your oscilloscope, you should see a small 50 or 60 hertz noise signal in the oscilloscope window when you touch the probe tip with your finger.

Moving your PicoScope PC Oscilloscope to another USB port

● Windows XP SP3

When you first installed the oscilloscope by plugging it into a [USB](#) port, Windows associated the Pico driver with that port. If you later move the oscilloscope to a different USB port, Windows will display the *New Hardware Found* wizard again. When this occurs, just click *Next* in the wizard to repeat the installation. If Windows gives a warning about Windows Logo Testing, click *Continue Anyway*. As all the software you need is already installed on your computer, there is no need to insert the Pico Software CD again.

● Windows Vista, Windows 7, and Windows 8

The process is automatic. When you move the device from one port to another, Windows displays an *Installing device driver software* message and then a *PicoScope 2000 series PC Oscilloscope* message. The PC Oscilloscope is then ready for use.

2.5 Connections

2.5.1 Connector diagrams

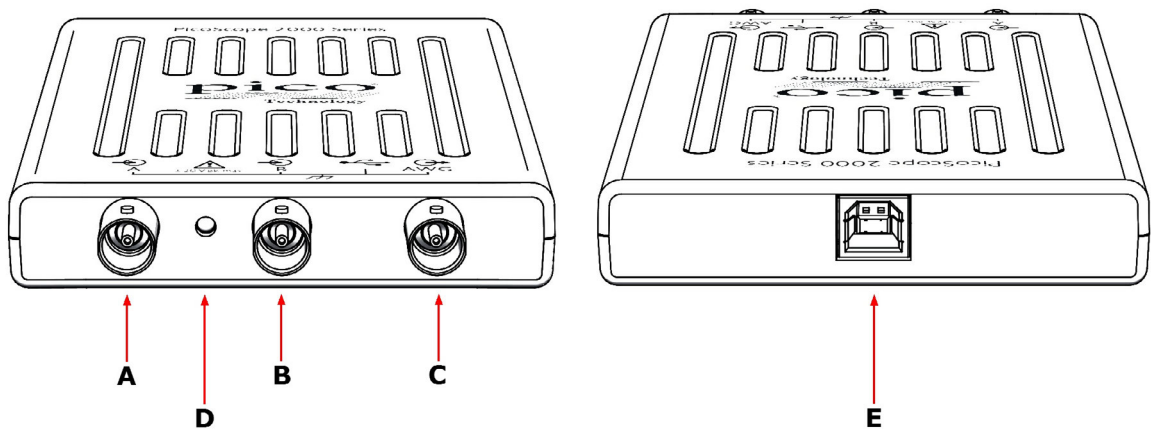

- A. [Input channel A](#)
- B. [Input channel B](#)
- C. [AWG output](#)
- D. LED: shows when the oscilloscope is sampling data
- E. [USB port](#)

2.5.2 Signal inputs

The PicoScope 2200A Series oscilloscopes have BNC oscilloscope connectors. The inputs have an impedance of 1 M Ω , so they are compatible with all standard scope probes including x10 attenuated types.

2.5.3 Compensating probes

We recommend that you compensate each oscilloscope probe before using it with your PicoScope. Compensation instructions specific to the probe are included in the leaflet supplied with the probe.

Connecting a probe for compensation

1. Connect your probe to the signal generator output as shown on the right.
2. Run the PicoScope software.
3. Click the AWG button and set the AWG to generate a 1 kHz 1 volt square wave.
4. Follow the compensation (or 'trimming') instructions in the probe leaflet.

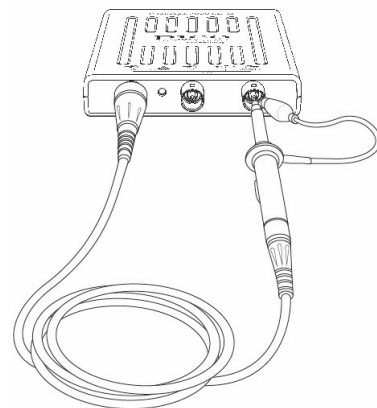

2.5.4 AWG connector

The AWG connector on the front panel carries the output of the oscilloscope's built-in signal generator, which can generate a number of built-in waveforms, as well as arbitrary waveforms from a user-defined table of data.

Instructions for use

- If you are using the PicoScope 6 program, refer to the *PicoScope 6 User's Guide* for information on how to configure the signal generator.
- If you are writing your own software, refer to either the:

PicoScope 2000 Series Programmer's Guide for PicoScope 2204A/5A, or
PicoScope 2000 Series (A API) Programmer's Guide for PicoScope 2206A/7A/8A

AWG output specifications

Refer to the PicoScope 2200A Series datasheet available on our website.

2.5.5 USB port

Connect the oscilloscope's USB port to your PC's USB 2.0 or USB 3.0 port using the USB cable supplied. The oscilloscope will work if connected to a USB 1.1 port but will operate at greatly reduced speed.

3 Glossary

AWG. Arbitrary waveform generator. This output can be used to drive a test signal from the BNC socket marked AWG into an external circuit or into one of the oscilloscope's input channels (using a BNC cable). The PicoScope software allows the generator to output standard waveforms, such as sine and square waves, or arbitrary waveforms defined by the user.

Analog bandwidth. The frequency at which the measured signal amplitude is 3 decibels below the true signal amplitude.

Block mode. A fast data collection mode. The PicoScope software puts the oscilloscope into this mode to achieve the fastest possible sampling rates. The oscilloscope collects data as fast as possible and then stops to transfer the data to the PC. During data transfer to the PC in block mode, the oscilloscope cannot sample data from its inputs.

Buffer size. The size of the oscilloscope's buffer memory, measured in samples. The buffer allows the oscilloscope to sample data faster than it can transfer it to the computer.

Coupling mode. To switch from AC coupling to DC coupling, or vice versa, select AC or DC from the control on the PicoScope toolbar. The AC setting filters out very low-frequency components of the input signal, including DC, and is suitable for viewing small AC signals superimposed on a DC or slowly changing offset. In this mode you can measure the peak-to-peak amplitude of an AC signal but not its absolute value. Use the DC setting for measuring the absolute value of a signal.

Device Manager. Device Manager is a Windows program that displays the current hardware configuration of your computer. Right-click on *My Computer*, choose *Properties*, then click the *Hardware* tab and the *Device Manager* button.

Driver. A program that controls a piece of hardware. The driver for the PicoScope 2200A Series PC Oscilloscopes is supplied in the form of a 32-bit Windows DLL, `ps2000a.dll`, or `ps2000.dll`. This is used by the PicoScope software to control the oscilloscope.

ETS. Equivalent Time Sampling. Constructs a picture of a repetitive signal by accumulating information over many similar wave cycles. This allows the oscilloscope to create a composite cycle that has more samples, and therefore better time resolution, than a single cycle. ETS cannot be used for one-shot signals.

GS/s. Billions of samples per second. Used to quantify the sampling rate of an oscilloscope.

Maximum sampling rate. A figure indicating the maximum number of samples the oscilloscope can acquire per second. The higher the sampling rate of the oscilloscope, the more accurate the representation of the high-frequency details in a fast signal.

MS/s. Millions of samples per second. Used to quantify the sampling rate of an oscilloscope.

PC Oscilloscope. A virtual instrument formed by connecting a PicoScope oscilloscope to a computer running the PicoScope software.

PicoScope software. A software program that accompanies all Pico PC Oscilloscopes. It turns your PC into an oscilloscope, spectrum analyser, and meter display.

Streaming mode. A data collection mode in which the oscilloscope samples data and returns it to the computer in a continuous stream. This mode allows the capture of more data than will fit in the oscilloscope's memory buffer, at sampling rates over 1 MS/s (PC dependent). The PicoScope program selects this mode for long timebases to enable the capture of very long sets of data.

Timebase. A timer that controls the speed at which the scope device captures data. At slow timebases this process is visible as PicoScope draws the trace across the scope view from left to right, but at fast timebases PicoScope draws the whole trace in a single operation. The timebase is measured in units of time (such as seconds) per division. There are ten divisions across the scope view, so the total time across the width of the view is ten times the "per division" setting.

USB 1.1. An early version of the Universal Serial Bus standard found on older PCs. Although your PicoScope will work with a USB 1.1 port, it will operate much more slowly than with a USB 2.0 or 3.0 port.

USB 2.0. Universal Serial Bus (High Speed). A standard port used to connect external devices to PCs. The high-speed data connection provided by a USB 2.0 port enables your PicoScope to achieve its maximum performance.

USB 3.0. A faster version of the Universal Serial Bus standard. Your PicoScope is fully compatible with USB 3.0 ports and will operate with the same performance as on a USB 2.0 port.

Vertical resolution. A value, in bits, indicating the precision with which the oscilloscope converts input voltages to digital values. PicoScope's Resolution Enhancement function can improve the effective vertical resolution.

Voltage range. The range of input voltages that the oscilloscope can measure. For example, a voltage range of ± 100 mV means that the oscilloscope can measure voltages between -100 mV and +100 mV. Input voltages outside this range will not be measured correctly, but will not damage the instrument as long as they remain within the protection limits stated in the specifications.

4 Appendix A: Declaration of Conformity



Pico Technology
 James House, Marlborough Road.
 Colmworth Business Park.
 Eaton Socon, St Neots, Cambridgeshire.
 PE19 8YP United Kingdom.
 Tel: +44 1480 396395. Fax: +44 1480 396296

EC Declaration of Conformity

Pico Technology declares that the following products comply with the requirements of the specified Directives and Standards as listed below. Technical documentation required to demonstrate compliance to the standards is available for inspection by the relevant enforcement authorities. Products carry the CE mark.

Products covered by this declaration:

PicoScope 2204A, 2205A, 2206A, 2207A, 2208A

2 channel USB oscilloscopes.

EU Directives covered by this declaration:

2004/108/EC - Electromagnetic Compatibility Directive.
 2006/95/EC - Low Voltage Equipment Directive.

The basis on which conformity is being declared:

EN61010-1:2010	Safety requirements for electrical equipment for measurement, control and laboratory use, general equipment requirements.
EN61010-2-030:2010	Particular requirements for testing and measuring circuits.
EN61326-1:2006	Electrical equipment for measurement, control and laboratory use – EMC requirements. Group 1, Class A equipment – (emissions section only)
EN61326-1:2006	Electrical equipment for measurement, control and laboratory use – EMC requirements. Basic Immunity – (immunity section only)
CFR 47:2009	Code of Federal Regulations FCC: part 15 Subpart B – Frequency devices – unintentional Radiators. Radiated emissions standard. Class A emissions.

Alan Tong
 Managing Director
 24 October 2013

Signed

Pico Technology Limited is an internationally registered trade mark
 Registered in England and Wales No. 2626181



Index

A

- Analog bandwidth 9
- Arbitrary waveform generator 12
- AWG connector 12

B

- Bandwidth (analog) 9
- BNC connector 11
- Buffer size 9

C

- Calibration 4, 5
- CE notice 6
- Connections 11

D

- Dimensions 9
- Disk space 10

E

- EMC Directive 6

F

- FCC notice 6

G

- GEN connector 12
- Grounding 4, 5

I

- Input range, maximum 4, 5
- Installation 10

L

- LED 11
- Low Voltage Directive (LVD) 6

M

- Mains voltages 4, 5

O

- Operating system 10
- Oscilloscope probe 11
 - compensating 11

P

- PicoScope software 10
- Processor 10

R

- Repairs 4, 5
- Resolution, vertical 9
- Returns 7

S

- Safety
 - symbols 3
 - warning 4, 5
- Sampling rate 9
- Scope probe 11
- Signal generator 11
 - output 12
- Signal Out connector 12
- Software licence conditions 7
- System memory 10
- System requirements 10

T

- Test equipment 4, 5
- Trademarks 7

U

- Upgrades 7
- USB port
 - changing 10
 - connecting 12
 - requirements 10

V

- Vertical resolution 9

W

- Warranty 8
- Windows, Microsoft 10



UK headquarters:

Pico Technology
James House
Colmworth Business Park
St. Neots
Cambridgeshire
PE19 8YP
United Kingdom

Tel: +44 (0) 1480 396 395
Fax: +44 (0) 1480 396 296

sales@picotech.com
www.picotech.com

US headquarters:

Pico Technology
320 N Glenwood Blvd
Tyler
Texas 75702
USA

Tel: +1 800 591 2796
Fax: +1 620 272 0981