



# PicoScope® 5000 Series

FLEXIBLE RESOLUTION OSCILLOSCOPES

## High Speed and High Resolution

FLEXIBLE HIGH-PERFORMANCE PC OSCILLOSCOPES

Flexible resolution, from 8 to 16 bits

Up to 200 MHz analog bandwidth

Up to 512 MS buffer memory

Up to 1 GS/s real-time sampling

Up to 10 GS/s equivalent-time sampling



Up to 200 MHz spectrum analyzer  
Built-in function generator or AWG  
USB-connected



Supplied with SDK including example programs • Free technical support • Free updates  
Software compatible with Windows 7, Windows 8 and Windows 10

[www.picotech.com](http://www.picotech.com)

## PicoScope: power, portability and versatility

Pico Technology continues to push the limits of PC oscilloscope design. For the first time in an oscilloscope, Pico Technology have used reconfigurable ADCs to offer a choice of 8-bit to 16-bit resolutions in a single product.

### Flexible resolution

Most digital oscilloscopes gain their high sampling rates by interleaving multiple 8-bit ADCs. Despite careful design, the interleaving process introduces errors that always make the dynamic performance worse than the performance of the individual ADC cores.

The new PicoScope 5000 Series scopes have a significantly different architecture in which multiple high-resolution ADCs can be applied to the input channels in different time-interleaved and parallel combinations to boost either the sampling rate or the resolution.

In time-interleaved mode, the ADCs are interleaved to provide 1 GS/s at 8 bits (see left diagram below). Interleaving reduces the performance of the ADCs, but the resulting (60 dB SFDR) is still much better than oscilloscopes that interleave 8-bit ADCs. This mode can also provide 500 MS/s at 12 bits resolution.

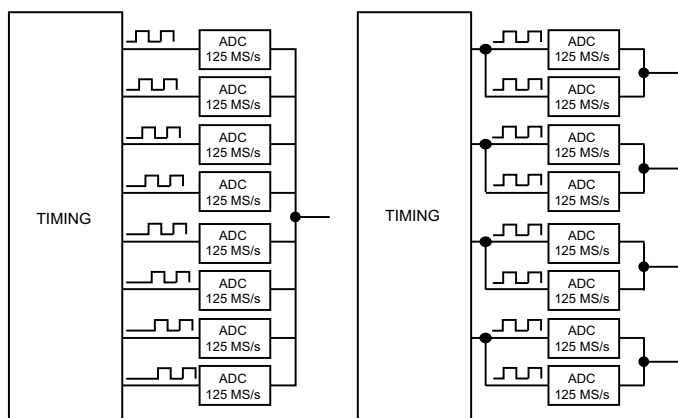

In parallel mode, multiple ADCs are sampled in phase on each channel to increase the resolution and dynamic performance (see right diagram above). Sampling in parallel with multiple ADCs and combining the output reduces noise and also both the integral and differential nonlinearity. Using parallel mode, resolution is increased to 14 bits at 125 MS/s per channel (70 dB SFDR). If only two channels are required then resolution can be increased to 15 bits, and in single-channel mode all the ADCs are combined to give a 16-bit mode at 62.5 MS/s. The software gives the choice of selecting the resolution or leaving the scope in “auto resolution” mode where the optimum resolution is used for the chosen settings.

### Portability

Pico Technology oscilloscopes are small, light and portable. In 2-channel mode the 5000 Series scopes can be powered from USB only, making them ideal for the engineer on the move. The external power supply is only needed when operating more than 2 channels. The 5000 Series oscilloscopes are suitable for field use in many applications, such as design, research, test, education, service and repair.

### High bandwidth, high sampling rate

Most USB-powered oscilloscopes have real-time sampling rates of only 100 or 200 MS/s, but the PicoScope 5000 Series offers up to 1 GS/s, and a maximum bandwidth of 200 MHz. Equivalent time sampling (ETS) mode can be used to further boost the sampling rate to 10 GS/s for a more detailed view of repetitive signals.

### Digital triggering

Most digital oscilloscopes sold today still use an analog trigger architecture based on comparators. This can cause time and amplitude errors that

cannot always be calibrated out. The use of comparators often limits the trigger sensitivity at high bandwidths.

In 1991 we pioneered the use of fully digital triggering using the actual digitized data. This technique reduces trigger errors and allows our oscilloscopes to trigger on the smallest signals, even at the full bandwidth. Trigger levels and hysteresis can be set with high precision and resolution.

Digital triggering also reduces re-arm delay and this, combined with the segmented memory, allows the triggering and capture of events that happen in rapid sequence. At the fastest timebase you can use rapid triggering to collect 10,000 waveforms in under 20 milliseconds. Our mask limit testing function can then scan through these waveforms to highlight any failed waveforms for viewing in the waveform buffer.

### Huge buffer memory

The PicoScope 5000 Series offers memory depths up to 512 million samples, more than any other oscilloscope in this price range.

Other oscilloscopes have high maximum sampling rates, but without deep memory they cannot sustain these rates on long timebases. Using its 512 MS buffer, the PicoScope 5444B can sample at 1 GS/s all the way down to 50 ms/div (500 ms total capture time).

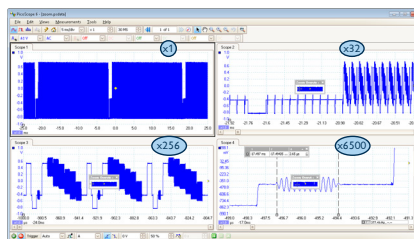

Managing all this data calls for some powerful tools.

There's a set of zoom buttons, plus an overview window that lets you zoom and reposition the display by simply dragging with the mouse. Zoom factors of several million are possible.

### Advanced triggers

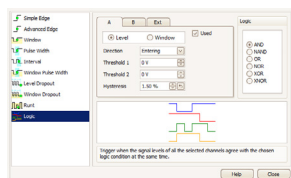

As well as the standard range of triggers found on all oscilloscopes, the PicoScope 5000 Series offers an industry-leading set of advanced triggers including pulse width, windowed and dropout triggers to help you capture the data you need.

### Arbitrary waveform and function generator

All units have a built-in function generator. As well as basic controls to set level, offset and frequency, more advanced controls allow you to sweep over a range of frequencies. Combined with the spectrum peak hold option this makes a powerful tool for testing amplifier and filter responses.

The PicoScope 5000 Series B models include an arbitrary waveform

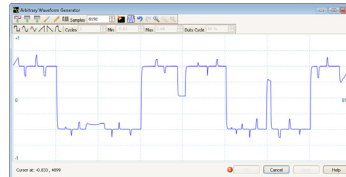

generator. Waveforms can be created or edited using the built-in AWG editor, imported from oscilloscope traces, or loaded from a spreadsheet.

### High signal integrity

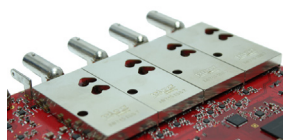

Most oscilloscopes are built down to a price; ours are built up to a specification.

Careful front-end design and shielding reduces noise, crosstalk and harmonic distortion. Years of oscilloscope experience leads to improved pulse response and bandwidth flatness.

## High-end features as standard

Buying a scope from some companies is a bit like buying a car. By the time you have added all the optional extras you need, the price has gone up considerably. With the PicoScope 5000 Series, high-end features such as mask limit testing, serial decoding, advanced triggering, measurements, math, XY mode, digital filtering and segmented memory are all included in the price.

To protect your investment, both the PC software and firmware inside the unit can be updated. We have a long history of providing new features for free as software downloads. Other companies make vague promises about future enhancements but we deliver on our promises year after year. Users of our products reward us by becoming lifelong customers, frequently recommending us to their colleagues.

The design of the PicoScope software ensures that maximum display area is available for waveform viewing. Even with a laptop you have a much bigger viewing area and higher resolution than a typical benchtop scope.

## Persistence display modes

See old and new data superimposed, with new data in a brighter color or shade. This makes it easy to see glitches and dropouts and to estimate their relative frequency. Choose between analog persistence and digital color, or create a custom display mode.

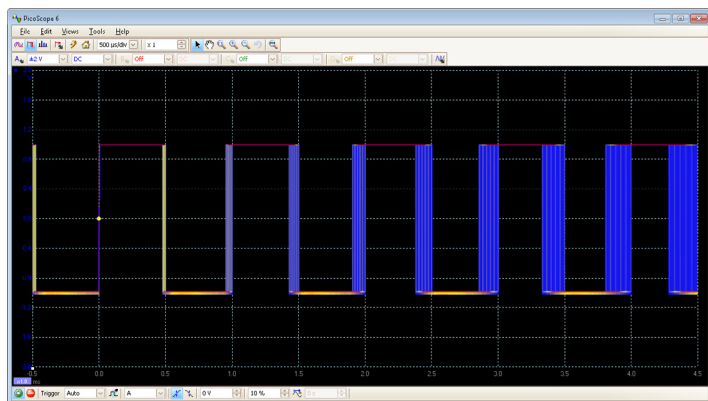

## Serial decoding

The PicoScope 5000 Series, with its deep memory, is ideal for serial decoding as it can capture thousands of frames of uninterrupted data. Protocols currently included are I<sup>2</sup>C, SPI, RS-232/UART, CAN, LIN and FlexRay. Expect this list to grow with free software updates.

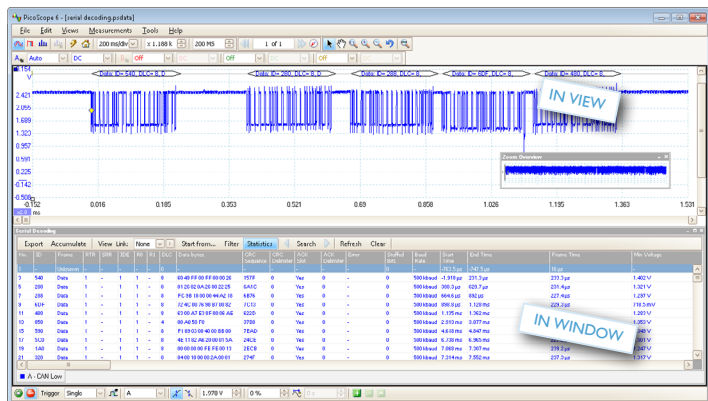

## High-speed data acquisition/digitizer

The drivers and software development kit supplied allow you to write your own software or interface to popular third-party software packages such as LabVIEW.

If the scope's ultra-deep memory isn't enough, the driver supports data streaming, a mode that captures gap-free continuous data through the

USB port directly to the PC's RAM or hard disk at a rate of over 10 MS/s (maximum speed is PC-dependent).

## Mask limit testing

This feature is specially designed for production and debugging environments. Capture a signal from a known working system, and PicoScope will draw a mask around it with your specified tolerance.

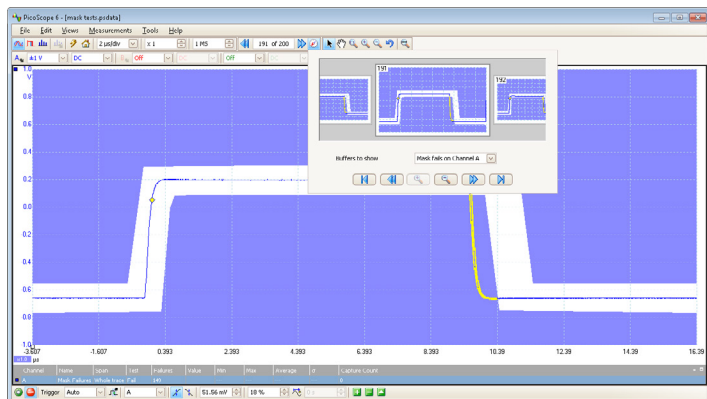

Connect the system under test, and PicoScope will highlight any parts of the waveform that fall outside the mask area. The highlighted details persist on the display, allowing the scope to catch intermittent glitches while you work on something else. The measurements window counts the number of failures, and can display other measurements and statistics at the same time. You can import and export masks as files.

## Custom probe settings

The custom probes feature allows you to correct for gain, attenuation, offsets and nonlinearities in special probes, or to convert to different units of measurement (such as current, power or temperature). You can save definitions to disk for later use.

## Spectrum analyzer

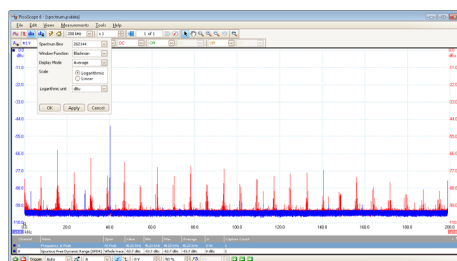

With a click of a button, you can display a spectrum plot of the selected channels with a maximum frequency up to 200 MHz. A full range of settings gives you control over the number of spectrum bands, window types and display modes: instantaneous, average, or peak-hold.

You can display multiple spectrum views with different channel selections and zoom factors, and see these alongside time-domain waveforms of the same data. A comprehensive set of automatic frequency-domain measurements, including THD, THD+N, SNR, SINAD and IMD, can be added to the display.

## Math channels

Create new channels by combining input channels and reference waveforms. Choose from a wide range of arithmetic, logarithmic,

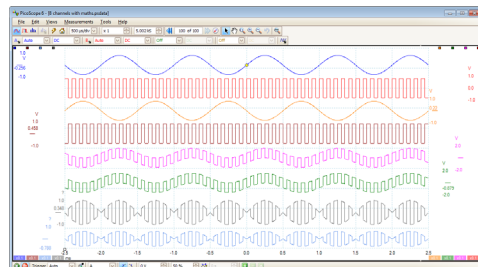

trigonometric and other functions. Define a function using the push-button control panel or type an equation in the text box.



**PicoScope:** the display can be as simple or as complex as you need. Begin with a single view of one channel, and then expand the display to include any number of live channels, math channels and reference waveforms.

**Tools > Serial decoding:** Decode multiple serial data signals and display the data alongside the physical signal or as a detailed table.

**Tools > Reference channels:** Store waveforms in memory or on disk and display them alongside live inputs. Ideal for diagnostics and production testing.

**Tools > Masks:** Automatically generate a test mask from a waveform or draw one by hand. PicoScope highlights any parts of the waveform that fall outside the mask and shows error statistics.

**Channel options:** Filtering, offset, resolution enhancement, custom probes and more.

**Auto setup button:** Configures the timebase and voltage ranges for stable display of signals.

**Trigger marker:** Drag to adjust trigger level and pre-trigger time.

**Oscilloscope controls:** Controls such as voltage range, scope resolution, channel enable, timebase and memory depth are placed on the toolbar for quick access, leaving the main display area clear for waveforms.

**Signal generator:** Generates standard signals or (on selected scopes) arbitrary waveforms. Includes frequency sweep mode.

**Waveform replay tools:** PicoScope automatically records up to 10,000 of the most recent waveforms. You can quickly scan through to look for intermittent events, or use the **Buffer Navigator** to search visually.

**Zoom and pan tools:** PicoScope allows a zoom factor of several million, which is necessary when working with the deep memory of the 5000 Series scopes. Either use the zoom-in, zoom-out and pan tools, or click and drag in the zoom overview window for fast navigation.

**Views:** PicoScope is carefully designed to make the best use of the display area. You can add new scope and spectrum views with automatic or custom layouts.

**Rulers:** Each axis has two rulers that can be dragged across the screen to make quick measurements of amplitude, time and frequency.

**Maths channels:** Combine input channels and reference waveforms using simple arithmetic, or create custom equations with trigonometric and other functions.

**Ruler legend:** Absolute and differential ruler measurements are listed here.

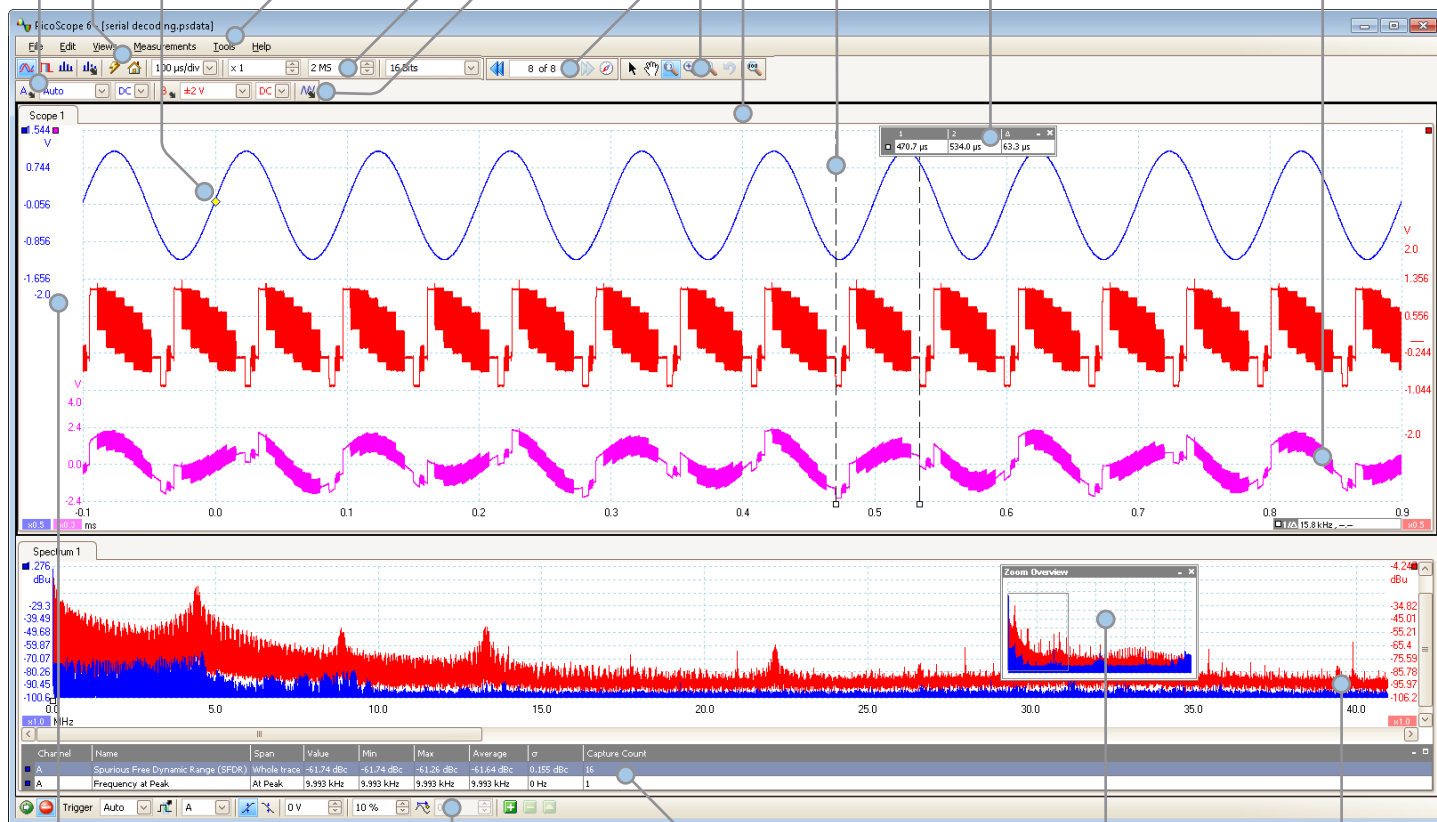

**Movable axes:** The vertical axes can be dragged up and down. This feature is particularly useful when one waveform is obscuring another. There's also an **Auto Arrange Axes** command.

**Trigger toolbar:** Quick access to main controls, with advanced triggers in a pop-up window.

**Automatic measurements:** Display calculated measurements for troubleshooting and analysis. You can add as many measurements as you need on each view. Each measurement includes statistical parameters showing its variability.

**Zoom overview:** Click and drag for quick navigation in zoomed views.

**Spectrum view:** View FFT data alongside scope view or independently.

# PicoScope 5000 Series Specifications

| VERTICAL                                    | PicoScope 5242A   | PicoScope 5442A | PicoScope 5242B | PicoScope 5442B | PicoScope 5243A   | PicoScope 5443A | PicoScope 5243B | PicoScope 5443B | PicoScope 5244A   | PicoScope 5444A | PicoScope 5244B | PicoScope 5444B |
|---|---|-----------------|-----------------|-----------------|---|-----------------|-----------------|-----------------|---|-----------------|-----------------|-----------------|
| Number of channels                          | 2   | 4               | 2               | 4               | 2   | 4               | 2               | 4               | 2   | 4               | 2               | 4               |
| Bandwidth (-3 dB)                           | All modes: 60 MHz   |                 |                 |                 | 8 to 15-bit modes: 100 MHz • 16-bit mode: 60 MHz  |                 |                 |                 | 8 to 15-bit modes: 200 MHz • 16-bit mode: 60 MHz  |                 |                 |                 |
| Bandwidth limiting (-3 dB)                  | 20 MHz, switchable  |                 |                 |                 | 20 MHz, switchable  |                 |                 |                 | 20 MHz, switchable  |                 |                 |                 |
| Rise time (calculated, 10% to 90%)          | All modes: 5.8 ns   |                 |                 |                 | 8 to 15-bit modes: 3.5 ns • 16-bit mode: 5.8 ns   |                 |                 |                 | 8 to 15-bit modes: 1.8 ns • 16-bit mode: 5.8 ns   |                 |                 |                 |
| Input connectors                            | BNCs on front panel   |                 |                 |                 | BNCs on front panel   |                 |                 |                 | BNCs on front panel   |                 |                 |                 |
| Resolution*                                 | 8 bits, 12 bits, 14 bits, 15 bits, 16 bits  |                 |                 |                 | 8 bits, 12 bits, 14 bits, 15 bits, 16 bits  |                 |                 |                 | 8 bits, 12 bits, 14 bits, 15 bits, 16 bits  |                 |                 |                 |
| Enhanced vertical resolution                | Hardware resolution + 4 bits  |                 |                 |                 | Hardware resolution + 4 bits  |                 |                 |                 | Hardware resolution + 4 bits  |                 |                 |                 |
| Input characteristics                       | 1 MΩ ±1%    13 pF, ±1 pF  |                 |                 |                 | 1 MΩ ±1%    13 pF, ±1 pF  |                 |                 |                 | 1 MΩ ±1%    13 pF, ±1 pF  |                 |                 |                 |
| Input coupling                              | AC/DC   |                 |                 |                 | AC/DC   |                 |                 |                 | AC/DC   |                 |                 |                 |
| Input sensitivity                           | 2 mV/div to 4 V/div   |                 |                 |                 | 2 mV/div to 4 V/div   |                 |                 |                 | 2 mV/div to 4 V/div   |                 |                 |                 |
| Input ranges                                | ±10 mV to ±20 V full scale, in 11 ranges  |                 |                 |                 | ±10 mV to ±20 V full scale, in 11 ranges  |                 |                 |                 | ±10 mV to ±20 V full scale, in 11 ranges  |                 |                 |                 |
| Analog offset range                         | ±250mV (10, 20, 50, 100, 200 mV ranges),<br>±2.5 V (500 mV, 1 V, 2 V ranges),<br>±20 V (5, 10, 20 V ranges)                                   |                 |                 |                 | ±250mV (10, 20, 50, 100, 200 mV ranges),<br>±2.5 V (500 mV, 1 V, 2 V ranges),<br>±20 V (5, 10, 20 V ranges) |                 |                 |                 | ±250mV (10, 20, 50, 100, 200 mV ranges),<br>±2.5 V (500 mV, 1 V, 2 V ranges),<br>±20 V (5, 10, 20 V ranges) |                 |                 |                 |
| DC accuracy                                 | ≥ 12-bit mode: ±0.25% typical @ 25°C (±1% of full scale max @ 20 - 30°C) • 8-bit mode: ±1% typical @ 25°C (±3% of full scale max @ 20 - 30°C) |                 |                 |                 |   |                 |                 |                 |   |                 |                 |                 |
| ±50 mV to ±20 V<br>±10 mV and ±20 mV ranges | All modes: ±2% typical @ 25°C (±5% of full scale max @ 20 - 30°C)   |                 |                 |                 |   |                 |                 |                 |   |                 |                 |                 |
| Overvoltage protection                      | ± 100 V (DC + AC peak)  |                 |                 |                 | ± 100 V (DC + AC peak)  |                 |                 |                 | ± 100 V (DC + AC peak)  |                 |                 |                 |

\* Maximum effective resolution is limited on the lowest voltage ranges: ±10 mV = 8 bits • ±20 mV = 12 bits. All other ranges can use full resolution.

| HORIZONTAL                           | PicoScope 5242A                                     | PicoScope 5442A | PicoScope 5242B | PicoScope 5442B | PicoScope 5243A                                     | PicoScope 5443A | PicoScope 5243B | PicoScope 5443B | PicoScope 5244A                                     | PicoScope 5444A | PicoScope 5244B | PicoScope 5444B |
|--------------------------------------|---|-----------------|-----------------|-----------------|---|-----------------|-----------------|-----------------|---|-----------------|-----------------|-----------------|
| Max. sampling rate                   | 8-bit mode  |                 | 12-bit mode     |                 | 14-bit mode   |                 | 15-bit mode     |                 | 16-bit mode   |                 |                 |                 |
| Any 1 channel                        | 1 GS/s  |                 | 500 MS/s        |                 | 125 MS/s  |                 | 125 MS/s        |                 | 62.5 MS/s   |                 |                 |                 |
| Any 2 channels                       | 500 MS/s  |                 | 250 MS/s        |                 | 125 MS/s  |                 | -               |                 | -   |                 |                 |                 |
| Any 3 channels                       | 250 MS/s  |                 | 125 MS/s        |                 | 125 MS/s  |                 | -               |                 | -   |                 |                 |                 |
| Four channels                        | 250 MS/s  |                 | 125 MS/s        |                 | 125 MS/s  |                 | -               |                 | -   |                 |                 |                 |
| Maximum ETS rate (8-bit mode only)   | 2.5 GS/s  |                 |                 |                 | 5 GS/s  |                 |                 |                 | 10 GS/s   |                 |                 |                 |
| Sampling rate (USB streaming)        | 10 MS/s in PicoScope 6. >10 MS/s using supplied API |                 |                 |                 | 10 MS/s in PicoScope 6. >10 MS/s using supplied API |                 |                 |                 | 10 MS/s in PicoScope 6. >10 MS/s using supplied API |                 |                 |                 |
| Timebase ranges                      | 2 ns/div to 1000 s/div                              |                 |                 |                 | 1 ns/div to 1000 s/div                              |                 |                 |                 | 500 ps/div to 1000 s/div                            |                 |                 |                 |
| Buffer memory** (8-bit)              | 16 MS   |                 | 32 MS           |                 | 64 MS   |                 | 128 MS          |                 | 256 MS  |                 | 512 MS          |                 |
| Buffer memory** (≥ 12-bit)           | 8 MS  |                 | 16 MS           |                 | 32 MS   |                 | 64 MS           |                 | 128 MS  |                 | 256 MS          |                 |
| Buffer memory** continuous streaming | 100 MS in PicoScope software                        |                 |                 |                 | 100 MS in PicoScope software                        |                 |                 |                 | 100 MS in PicoScope software                        |                 |                 |                 |
| Waveform buffer (no. of segments)    | 10,000 in PicoScope software                        |                 |                 |                 | 10,000 in PicoScope software                        |                 |                 |                 | 10,000 in PicoScope software                        |                 |                 |                 |
| Timebase accuracy (drift)            | ±50 ppm (±5 ppm/year)                               |                 |                 |                 | ±2 ppm (±1 ppm/year)                                |                 |                 |                 | ±2 ppm (±1 ppm/year)                                |                 |                 |                 |
| Sample jitter                        | 3 ps RMS, typical                                   |                 |                 |                 | 3 ps RMS, typical                                   |                 |                 |                 | 3 ps RMS, typical                                   |                 |                 |                 |

\*\* Shared between active channels

| DYNAMIC PERFORMANCE (typical; analog channels) | Better than 400:1 up to full bandwidth (equal voltage ranges)   |  |  |  |  |  |  |  |  |  |  |  |
|--|---|--|--|--|--|--|--|--|--|--|--|--|
| Crosstalk                                      | 8-bit mode: < -60 dB at 100 kHz full scale input • ≥ 12-bit mode: < -70 dB at 100 kHz full scale input                  |  |  |  |  |  |  |  |  |  |  |  |
| Total harmonic distortion (THD)                | 8 and 12-bit: > 60 dB at 100 kHz full scale input • 14 to 16-bit: > 70 dB at 100 kHz full scale input                   |  |  |  |  |  |  |  |  |  |  |  |
| SFDR   | 8-bit mode 120 μV RMS • 12-bit mode 110 μV RMS • 14-bit mode 100 μV RMS • 15-bit mode 85 μV RMS • 16-bit mode 70 μV RMS |  |  |  |  |  |  |  |  |  |  |  |
| Noise (on 50 mV range)                         | (±0.3 dB, -3 dB) from DC to full bandwidth  |  |  |  |  |  |  |  |  |  |  |  |
| Bandwidth flatness                             | (±0.3 dB, -3 dB) from DC to full bandwidth  |  |  |  |  |  |  |  |  |  |  |  |

# PicoScope 5000 Series Specifications

|                                  | PicoScope 5242A/5442A  | PicoScope 5242B/5442B                                      | PicoScope 5243A/5443A           | PicoScope 5243B/5443B                                      | PicoScope 5244A/5444A           | PicoScope 5244B/5444B                                      |
|----------------------------------|--|--|---------------------------------|--|---------------------------------|--|
| <b>TRIGGERING</b>                |  |  |                                 |  |                                 |  |
| Source                           | All channels   |  | All channels                    |  | All channels                    |  |
| Trigger modes                    | None, Auto, Repeat, Single, Rapid (segmented memory)   |  |                                 |  |                                 |  |
| Advanced triggers                | Edge, Window, Pulse width, Window pulse width, Dropout, Window dropout, Interval, Runt pulse, Logic                        |  |                                 |  |                                 |  |
| Trigger types (ETS mode)         | Rising, falling  |  |                                 |  |                                 |  |
| Sensitivity                      | Digital triggering provides 1 LSB accuracy up to full bandwidth of scope. • ETS mode: Typical 10 mV p-p, at full bandwidth |  |                                 |  |                                 |  |
| Maximum pre-trigger capture      | 100% of capture size   |  |                                 |  |                                 |  |
| Maximum post-trigger capture     | 4 billion samples  |  |                                 |  |                                 |  |
| Trigger re-arm time              | < 2 $\mu$ s on fastest timebase  |  |                                 |  |                                 |  |
| Maximum trigger rate             | Up to 10,000 waveforms in a 20 ms burst  |  |                                 |  |                                 |  |
| <b>EXTERNAL TRIGGER INPUT</b>    |  |  |                                 |  |                                 |  |
| Trigger types                    | Edge, pulse width, dropout, interval, logic  |  |                                 |  |                                 |  |
| Input characteristics            | Front panel BNC, 1 M $\Omega$ $\pm$ 1%    13 pF $\pm$ 1 pF   |  |                                 |  |                                 |  |
| Bandwidth                        | 60 MHz   |  | 100 MHz                         |  | 200 MHz                         |  |
| Voltage range                    | $\pm$ 5 V, DC coupled  |  |                                 |  |                                 |  |
| Overvoltage protection           | $\pm$ 100 V (DC + AC peak)   |  |                                 |  |                                 |  |
| <b>FUNCTION GENERATOR</b>        |  |  |                                 |  |                                 |  |
| Standard output signals          | Sine, square, triangle, DC voltage   |  |                                 |  |                                 |  |
| Output signals (B models only)   | -  | Ramp up/down, sinc, Gaussian, half-sine, white noise, PRBS | -                               | Ramp up/down, sinc, Gaussian, half-sine, white noise, PRBS | -                               | Ramp up/down, sinc, Gaussian, half-sine, white noise, PRBS |
| Standard signal frequency        | DC to 20 MHz   |  |                                 |  |                                 |  |
| Output frequency accuracy        | $\pm$ 50 ppm ( $\pm$ 5 ppm/year)   |  | $\pm$ 2 ppm ( $\pm$ 1 ppm/year) |  | $\pm$ 2 ppm ( $\pm$ 1 ppm/year) |  |
| Output frequency resolution      | < 50 mHz   |  |                                 |  |                                 |  |
| Output voltage range             | $\pm$ 2 V with $\pm$ 1% DC accuracy  |  |                                 |  |                                 |  |
| Output voltage adjustment        | Signal amplitude and offset adjustable in approx. 0.25 mV steps within overall $\pm$ 2 V range                             |  |                                 |  |                                 |  |
| Amplitude flatness               | < 2 dB to 20 MHz, typical @ 50 $\Omega$ load   |  |                                 |  |                                 |  |
| SFDR                             | > 70 dB, 10 kHz full scale sine wave   |  |                                 |  |                                 |  |
| Connector type                   | BNC, 50 $\Omega$ output impedance  |  |                                 |  |                                 |  |
| Overvoltage protection           | $\pm$ 20 V   |  |                                 |  |                                 |  |
| Sweep modes                      | Up, down, or alternating, with selectable start/stop frequencies and increments  |  |                                 |  |                                 |  |
| <b>AWG (B models only)</b>       |  |  |                                 |  |                                 |  |
| Update rate                      | -  | 200 MS/s   | -                               | 200 MS/s   | -                               | 200 MS/s   |
| Buffer size                      | -  | 16 kS  | -                               | 32 kS  | -                               | 48 kS  |
| Resolution                       | -  | 14 bits (output step size approximately 0.25 mV)           | -                               | 14 bits (output step size approximately 0.25 mV)           | -                               | 14 bits (output step size approximately 0.25 mV)           |
| Bandwidth                        | -  | > 20 MHz   | -                               | > 20 MHz   | -                               | > 20 MHz   |
| Rise time (10% to 90%)           | -  | < 10 ns  | -                               | < 10 ns  | -                               | < 10 ns  |
| <b>PROBE COMPENSATION OUTPUT</b> |  |  |                                 |  |                                 |  |
| Output characteristics           | 600 $\Omega$   |  |                                 |  |                                 |  |
| Output frequency                 | 1 kHz  |  |                                 |  |                                 |  |
| Output level                     | 3 V pk-pk  |  |                                 |  |                                 |  |
| Overvoltage protection           | 10 V   |  |                                 |  |                                 |  |

# PicoScope 5000 Series Specifications

| SPECTRUM ANALYZER             | PicoScope 5242A/5442A   | PicoScope 5242B/5442B | PicoScope 5243A/5443A         | PicoScope 5243B/5443B | PicoScope 5244A/5444A         | PicoScope 5244B/5444B |
|-------------------------------|---|-----------------------|-------------------------------|-----------------------|-------------------------------|-----------------------|
| Frequency range               | DC to 60 MHz  |                       | DC to 100 MHz                 |                       | DC to 200 MHz                 |                       |
| Display modes                 | Magnitude, average, peak hold   |                       | Magnitude, average, peak hold |                       | Magnitude, average, peak hold |                       |
| Windowing functions           | Rectangular, Gaussian, triangular, Blackman, Blackman-Harris, Hamming, Hann, flat-top   |                       |                               |                       |                               |                       |
| Number of FFT points          | Selectable from 128 to 1 million in powers of 2   |                       |                               |                       |                               |                       |
| <b>MATH CHANNELS</b>          |   |                       |                               |                       |                               |                       |
| Functions                     | -x, x+y, x-y, x*y, x/y, x^y, sqrt, exp, ln, log, abs, norm, sign, sin, cos, tan, arcsin, arccos, arctan, sinh, cosh, tanh, delay, average, frequency, derivative, integral, min, max, peak, duty, highpass, lowpass, bandpass, bandstop |                       |                               |                       |                               |                       |
| Operands                      | A, B, C, D (input channels), T (time), reference waveforms, pi  |                       |                               |                       |                               |                       |
| <b>AUTOMATIC MEASUREMENTS</b> |   |                       |                               |                       |                               |                       |
| Oscilloscope                  | AC RMS, true RMS, DC average, cycle time, frequency, duty cycle, falling rate, fall time, rising rate, rise time, high pulse width, low pulse width, maximum, minimum, peak to peak   |                       |                               |                       |                               |                       |
| Spectrum                      | Frequency at peak, amplitude at peak, average amplitude at peak, total power, THD %, THD dB, THD+N, SFDR, SINAD, SNR, IMD   |                       |                               |                       |                               |                       |
| Statistics                    | Minimum, maximum, average and standard deviation  |                       |                               |                       |                               |                       |
| <b>SERIAL DECODING</b>        |   |                       |                               |                       |                               |                       |
| Protocols                     | 1-Wire, ARINC 429, CAN, DCC, DMX512, Ethernet 10Base-T and 100Base-TX, FlexRay, I <sup>2</sup> C, I <sup>2</sup> S, LIN, PS/2, SENT, SPI, UART (RS-232 / RS-422 / RS-485), USB  |                       |                               |                       |                               |                       |
| <b>MASK LIMIT TESTING</b>     |   |                       |                               |                       |                               |                       |
| Statistics                    | Pass/fail, failure count, total count   |                       |                               |                       |                               |                       |
| <b>DISPLAY</b>                |   |                       |                               |                       |                               |                       |
| Interpolation                 | Linear or sin(x)/x  |                       |                               |                       |                               |                       |
| Persistence modes             | Digital color, analog intensity, custom, or none  |                       |                               |                       |                               |                       |
| <b>GENERAL</b>                |   |                       |                               |                       |                               |                       |
| PC connectivity               | USB 2.0 hi-speed (USB 1.1 and USB 3.0 compatible)   |                       |                               |                       |                               |                       |
| Power requirements            | 1 A (2 channels) from 2 USB ports (double-headed cable supplied) or 1.5 A at 5 V (up to 4 channels) from AC adaptor   |                       |                               |                       |                               |                       |
| Dimensions                    | 190 x 170 x 40 mm (including connectors)  |                       |                               |                       |                               |                       |
| Weight                        | < 0.5 kg  |                       |                               |                       |                               |                       |
| Temperature range             | Operating: 0 °C to 40 °C (20 °C to 30 °C for stated accuracy). Storage: -20 °C to 60 °C.  |                       |                               |                       |                               |                       |
| Humidity range                | Operating: 5 %RH to 80 %RH non-condensing. Storage: 5 %RH to 95 %RH non-condensing.   |                       |                               |                       |                               |                       |
| Environment                   | Dry locations only; up to 2000 m altitude   |                       |                               |                       |                               |                       |
| Safety approvals              | Designed to EN 61010-1:2010   |                       |                               |                       |                               |                       |
| EMC approvals                 | Tested to EN61326-1:2006 and FCC Part 15 Subpart B  |                       |                               |                       |                               |                       |
| Environmental approvals       | RoHS and WEEE compliant   |                       |                               |                       |                               |                       |
| Software/PC requirements      | PicoScope 6: Microsoft Windows 7, Windows 8 (Windows RT not supported) or Windows 10<br>SDK and example programs: Microsoft Windows XP (SP3), Windows Vista (SP2), Windows 7, Windows 8 (Windows RT not supported) or Windows 10        |                       |                               |                       |                               |                       |
| Accessories                   | USB cable(s), 2 or 4 probes in probe case, AC adaptor for 4-channel scope   |                       |                               |                       |                               |                       |
| Languages                     | Simplified Chinese, Czech, Danish, Dutch, English, Finnish, French, German, Greek, Hungarian, Italian, Japanese, Korean, Norwegian, Polish, Portuguese, Romanian, Russian, Spanish, Swedish and Turkish                                 |                       |                               |                       |                               |                       |

## Connections

The front panels of the 2-channel PicoScope 5000 Series oscilloscopes have:

- 2 x BNC analog input channels
- 1 x BNC external trigger input
- 1 x BNC AWG/function generator output
- 1 x probe compensation output

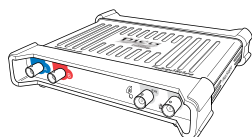

The front panels of the 4-channel PicoScope 5000 Series oscilloscopes have:

- 4 x BNC analog input channels
- 1 x BNC external trigger input
- 1 x BNC AWG/function generator output
- 1 x probe compensation output

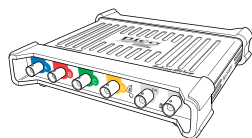

The rear panels of all oscilloscopes in the PicoScope 5000 Series have:

- 1 x DC power socket
- 1 x USB 2.0 port



## Kit contents and accessories

Your PicoScope 5000 Series oscilloscope kit contains the following items:

- PicoScope 5000 Series oscilloscope
- 2 x probes (2-channel scopes)
- 4 x probes (4-channel scopes)
- Double-headed USB 2.0 cable
- Standard USB 2.0 cable (4-channel scopes only)
- Mains power adaptor (4-channel scopes only)
- Quick Start Guide
- Software and Reference CD

## Probes

Your PicoScope 5000 Series oscilloscope kit comes with probes specifically trimmed to match the performance of your oscilloscope. The part numbers for these probes are as follows:



| 60 MHz | 150 MHz | 250 MHz |
|--------|---------|---------|
| MI007  | TA132   | TA131   |

## Ordering information

| ORDER CODE | DESCRIPTION     | NUMBER OF CHANNELS | BANDWIDTH | FUNC. GEN/ AWG     | BUFFER SIZE | PROBES SUPPLIED | GBP* | USD* | EUR* |
|------------|-----------------|--------------------|-----------|--------------------|-------------|-----------------|------|------|------|
| PP863      | PicoScope 5242A | 2                  | 60 MHz    | Function generator | 16 MS       | 2 x 60 MHz      | 699  | 1155 | 979  |
| PP864      | PicoScope 5242B | 2                  | 60 MHz    | AWG                | 32 MS       | 2 x 60 MHz      | 799  | 1315 | 1115 |
| PP865      | PicoScope 5243A | 2                  | 100 MHz   | Function generator | 64 MS       | 2 x 150 MHz     | 899  | 1485 | 1255 |
| PP866      | PicoScope 5243B | 2                  | 100 MHz   | AWG                | 128 MS      | 2 x 150 MHz     | 999  | 1645 | 1395 |
| PP867      | PicoScope 5244A | 2                  | 200 MHz   | Function generator | 256 MS      | 2 x 250 MHz     | 1095 | 1805 | 1535 |
| PP868      | PicoScope 5244B | 2                  | 200 MHz   | AWG                | 512 MS      | 2 x 250 MHz     | 1195 | 1975 | 1675 |
| PP869      | PicoScope 5442A | 4                  | 60 MHz    | Function generator | 16 MS       | 4 x 60 MHz      | 949  | 1565 | 1325 |
| PP870      | PicoScope 5442B | 4                  | 60 MHz    | AWG                | 32 MS       | 4 x 60 MHz      | 1095 | 1805 | 1535 |
| PP871      | PicoScope 5443A | 4                  | 100 MHz   | Function generator | 64 MS       | 4 x 150 MHz     | 1245 | 2055 | 1745 |
| PP872      | PicoScope 5443B | 4                  | 100 MHz   | AWG                | 128 MS      | 4 x 150 MHz     | 1395 | 2305 | 1955 |
| PP873      | PicoScope 5444A | 4                  | 200 MHz   | Function generator | 256 MS      | 4 x 250 MHz     | 1545 | 2545 | 2165 |
| PP874      | PicoScope 5444B | 4                  | 200 MHz   | AWG                | 512 MS      | 4 x 250 MHz     | 1695 | 2795 | 2375 |

\*Prices are correct at the time of publication. VAT not included.

Please contact Pico Technology for the latest prices before ordering.

### UK headquarters:

Pico Technology  
James House  
Colmworth Business Park  
St. Neots  
Cambridgeshire  
PE19 8YP

United Kingdom

+44 (0) 1480 396 395

+44 (0) 1480 396 296

sales@picotech.com

### US headquarters:

Pico Technology  
320 N Glenwood Blvd  
Tyler  
Texas 75702  
United States

+1 800 591 2796

+1 620 272 0981

sales@picotech.com

Errors and omissions excepted. *Windows* is a registered trade mark of Microsoft Corporation in the United States and other countries. *Pico Technology* and *PicoScope* are internationally registered trade marks of Pico Technology Ltd. MM040.en-6. Copyright © 2013–2016 Pico Technology Ltd. All rights reserved.